

Part Number : SC-SSA02FB.01 (main part)
Product Category : Housing Female
Family Name/Series : 060[1.50mm]
Material: PA66 - ZYTEL MT409AHS BK010 (Dupont)

Temperature range: +110C ... -20C (according to certificate no. W/092014/0003)
Waterproof: IP55 (according to certificate of conformity no. Z/12.027/13 in connection with EN 60529:1991+A1:2000 standard)

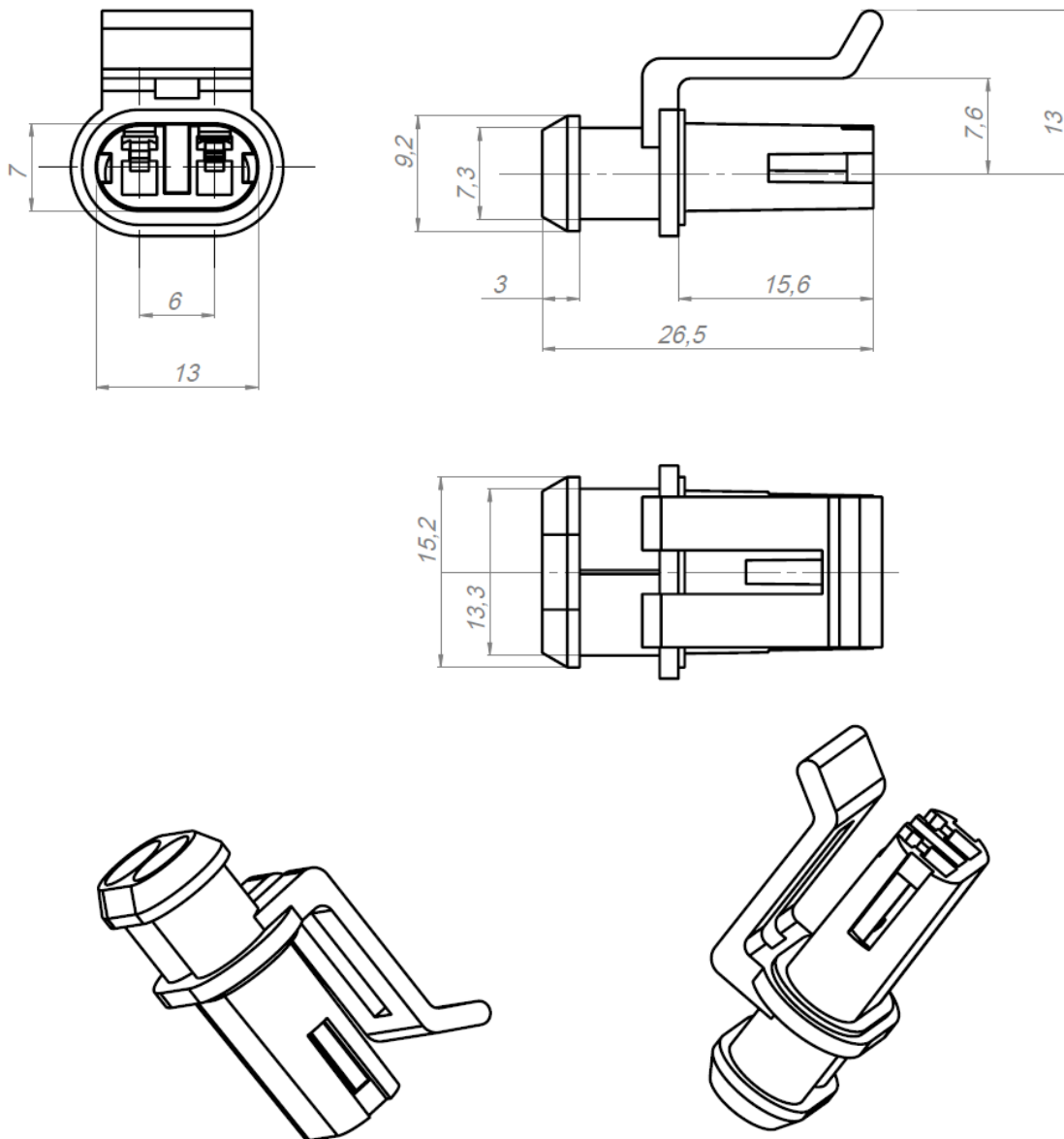

Part Number : SC-SSA02FB.02 (lock part)
Product Category : Housing Female
Family Name/Series : 060[1.50mm]
Material: PA66 - ZYTEL 70G30HSLR NC010 (Dupont)

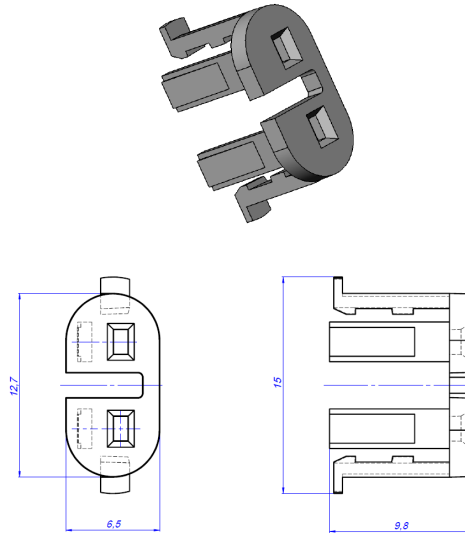

Part Number : SC-SSA02FB.03 (ring seal)
Product Category : Housing Female
Family Name/Series : 060[1.50mm]
Material: PA66 - SILICONE

